



EXPANDERS
ACCESSORIES
MISCELLANEOUS ITEMS
STEPS & TROLLEYS

www.atlashandlinguk.co.uk

01527 501 148

SCENE SHIFTERS

SERIES: ICSKATE

BRACKET: **FABRICATED**
BEARING: **PLAIN/BALL BEARING**



WHEELS

ICSKATE

SWIVEL

NYLON

ICS/50NB2LLNY	50	14		135x110	105x80	10	95	300
ICS/100DRHBH12NYBJ	100	35		135x110	105x80	13	163	460
ICS/125DRHBH12NYBJ	125	35		135x110	105x80	13	183	460

STEEL

ICS/50NB2LLST	50	14		135x110	105x80	10	95	300
---------------	----	----	--	---------	--------	----	----	-----

BLUE ELASTICATED

ICS/100DRHBH12BNB	100	36		135x110	105x80	13	163	460
ICS/125DRHBH12BNB	125	36		135x110	105x80	13	183	460

CAST IRON

ICS/100DRHBH12CIBJ	100	36		135x110	105x80	13	163	460
ICS/125DRHBH12CIBJ	125	38		135x110	105x80	13	183	460

POLY ALUMINIUM

ICS/100DRHBH12PTABJ	100	40		135x110	105x80	13	163	460
ICS/125DRHBH12PTABJ	125	40		135x110	105x80	13	183	460

POLY CAST IRON

ICS/35NBLL2PTBJ	35	28		85x85	55x55	10	85	300
ICS/50NB2LLPT	50	14		135x110	105x80	10	95	300
ICS/100DRHBH12PTBJ	100	38		135x110	105x80	13	163	460
ICS/125DRHBH12PTBJ	125	38		135x110	105x80	13	183	460

RUBBER CAST IRON

ICS/100DRHBH12RTBJ	100	36		135x110	105x80	13	163	460
ICS/125DRHBH12RTBJ	125	38		135x110	105x80	13	183	460



PLATE OPTIONS

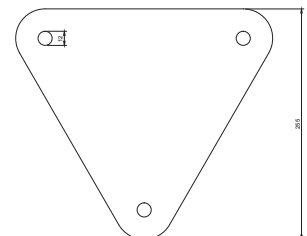
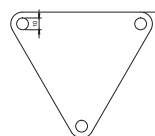
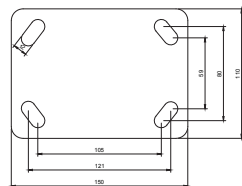
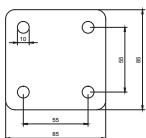

PALLET ROLLERS

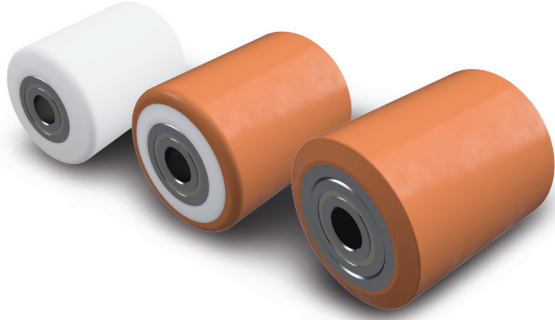

PALLET ROLLERS NYLON OR POLYURETHANE

Pallet Rollers are specifically designed as replacement pallet rollers on pallet trucks and fork lift trucks. With an extra wide tread and ball journal bearings these durable and robust hardworking pallet rollers can take loads of up to 950k.

With a variety of pallet roller wheel diameters to suit your requirements in either polyurethane or nylon.

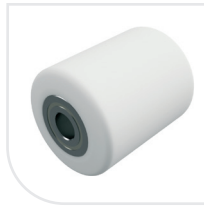

NYLON

82x60WNYBJM	82	60		17/20/25	60	600
82x70WNYBJM	82	70		17/20/25	70	700
82x100WNYBJM	82	100		17/20/25	100	1000
85x60WNYBJ	85	60		17/20/25	60	600
85x70WNYBJ	85	70		17/20/25	70	700
85x90WNYBJ	85	90		17/20/25	90	900
85x100WNYBJ	85	100		17/20/25	100	1000



POLYURETHANE

Polyurethane on Nylon

82x70WPNBJ	82	70		17/20/25	70	500
82x100WPNBJ	82	100		17/20/25	100	850
85x90WPNBJ	85	90		17/20/25	90	750



POLYURETHANE

Polyurethane on Cast Iron

70x70WPTBJM	70	70		15	70	500
75x75WPTBJM	75	75		17/20/25	75	570
80x60WPTBJM	80	60		17/20/25	60	550
82x60WPTBJM	82	60		17/20/25	60	600
82x70WPTBJM	82	70		17/20/25	70	700
82x75WPTBJM	82	75		17/20/25	75	750
82x90WPTBJM	82	90		17/20/25	90	900
82x100WPTBJM	82	100		17/20/25	100	1000
85x60WPTBJM	85	60		17/20/25	60	700
85x70WPTBJM	85	70		17/20/25	70	700
85x75WPTBJM	85	75		17/20/25	75	750
85x80WPTBJM	85	80		17/20/25	80	800
85x90WPTBJM	85	90		17/20/25	90	900
85x100WPTBJM	85	100		17/20/25	100	1000

EXPANDERS & ACCESSORIES

EXPANDERS



ES	INSIDE-TUBE MEASUREMENT	TUBE
Square Expander		
ES21.5	19-21.5	SQUARE
ES24	21.5-24	SQUARE
ES27	24-27	SQUARE
ES30	27-30	SQUARE
ES35	32-35	SQUARE
ES40	36-40	SQUARE



ER	INSIDE-TUBE MEASUREMENT	TUBE
Round Expander		
ER21.5	19-21.5	ROUND
ER24	21.5-24	ROUND
ER27	24-27	ROUND
ER30	27-30	ROUND
ER35	32-35	ROUND
ER40	36-40	ROUND

ACCESSORIES

STAIR CLIMBERS 	ROLLER BEARING ASSEMBLIES 	BALL BEARINGS 	BALL BEARINGS 	AXLE BUSHES 	AXLE SPACERS
---------------------------	--------------------------------------	--------------------------	--------------------------	------------------------	-------------------------

SPRING LOADED GATE CASTOR

SPECIAL PURPOSE CASTOR SPECIFICALLY DESIGNED TO HELP SUPPORT THE ENDS OF WIDE SWING GATES OR DOORS, HELPING REDUCE STRESSES AND STRAINS ON SUPPORTS AND HINGES, AND AID SMOOTHER OPERATION. THEY WILL PROVIDE UP TO 70KG OF SUPPORT AND CAN ACCOMMODATE A MAXIMUM OF 75MM/3" OF UPWARDS COMPRESSION/GROUND HEIGHT VARIATION.

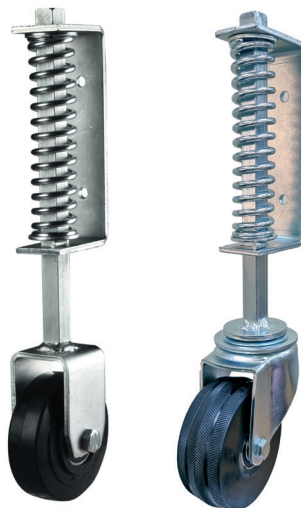

KEY DIMENSIONS

Side Elevation

Fixing Plate

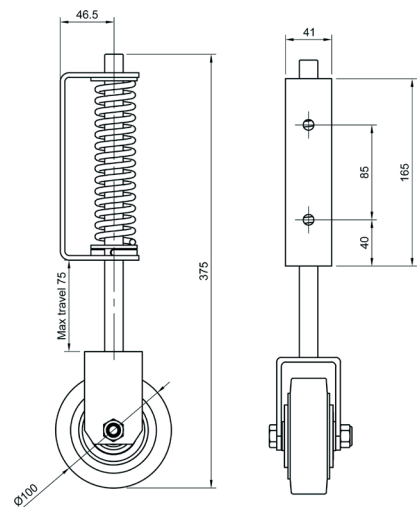

ADJUSTABLE FEET



ADJUSTABLE FEET

MILD STEEL BRIGHT ZINC PLATE STEMS WITH PLASTIC BASES

STEMS: MILD STEEL BZP BASES: POLYPROPYLENE



25MM TO 55MM
80MM TO 105MM
STEMS
BASES
WEIGHT

CONICAL ONLY
CONICAL OR BOLT DOWN
MILD STEEL BRIGHT ZINC PLATE STEMS
POLYPROPYLENE
50KG - 450KG

STAINLESS STEM & PLASTIC BASES

STEMS: STAINLESS STEEL BASES: POLYPROPYLENE BLACK OR WHITE



25MM TO 55MM
80MM TO 105MM
STEMS
BASES
WEIGHT

CONICAL ONLY
CONICAL OR BOLT DOWN
STAINLESS STEEL
POLYPROPYLENE BLACK OR WHITE
50KG - 450KG

SOLID STAINLESS STEEL STEMS & BASES

STEMS: STAINLESS STEEL BASES: STAINLESS STEEL



38MM TO 76MM
76MM TO 102MM
STEMS
BASES
WEIGHT

CONICAL ONLY
CONICAL OR BOLT DOWN
STAINLESS STEEL
STAINLESS STEEL
300KG - 2000KG

STEPS / STEP TRAY TROLLEYS

STEP LADDERS

All classic models are fully welded throughout and available with ribbed rubber or anti-slip treads.

Close fitting continuous single rail guard around top platform, extending down each side of stairway as a short handrail.	Spiggot OD 18.5mm*
Fitted with dome covered spring loaded, 50mm dia swivel castors which retract when weight is applied to the steps, giving them firm contact with the floor.	Spiggot Length 85mm
Grey non marking tyres.	Fixing Hole dia: 5mm
Dome covers have a double rolled bottom edge together with a protective cover strip, giving a neat appearance and reasonable protection to carpets and other floor surfaces.	Fixing hole centre from base of tube 10mm
	The I/D of the tube on the step itself that we have is 24.1mm* so there is a fair amount of clearance / tolerance.



TREAD (INC PLATFORM)	2	3	4	5
AVERAGE WORKING HEIGHT	2.00M	2.26M	2.52M	2.77M
PLATFORM HEIGHT MM	508	762	1016	1270
PLATFORM WIDTH MM	380	380	380	380
PLATFORM DEPTH MM	280	280	280	280
O/ALL H (INC RAILS)MM	1185	1425	1683	1940
O/ALL WIDTH MM	580	580	580	580
O/ALL DEPTH MM	540	795	955	1120
WEIGHT KGS	12	14	17	20
RIBBED RUBBER TREADS REF	S005	S009	S011	S013
ANTI SLIP TREADS REF	S006	S010	S012	S014

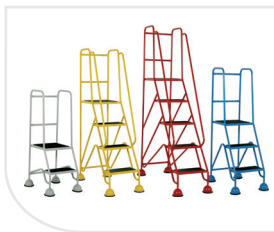

TREAD (INC PLATFORM)	2	2	2	3	4	5
HANDRAILS	NONE	SINGLE	FULL	FULL	FULL	FULL
PLATFORM HEIGHT MM	508	508	508	762	1016	1270
PLATFORM WIDTH MM	406	406	406	406	406	406
PLATFORM DEPTH MM	380	380	380	380	380	380
O/ALL H (INC RAILS)MM	570	1175	1175	1430	1680	1935
O/ALL WIDTH MM	556	556	556	556	556	556
O/ALL DEPTH MM	650	650	650	790	1005	1225
WEIGHT KGS	7	9	11	14	17	20
RIBBED RUBBER TREADS REF	S218	S220	S221	S222	S223	S224
ANTI SLIP TREADS REF	S219	S225	S226	S227	S228	S229

STEP TRAY TROLLEYS



3 Step, 3 Tray Tiers

Spring loaded step unit, with ribbed rubber treads, locates firmly on floor when foot placed on first step, immobilising trolley.

Top tread height 686mm

Fully welded construction, from RSA angle and ERW tube. Rubber feet fitted to step unit. Blue Epoxy finish.



5 Step, 3 Tray Tiers

Fully welded from RSA angle and ERW tubes.

Fitted with 2 retractable castors in front and 2 fixed castors to rear, each with 125mm rubber tyred wheels and roller bearings.

Front castors retract with hand operated lever to immobilise trolley. Fixed steps, handrail fitted to each side and across the top.

HOOF CASTOR

Hoof Cup Feet steps are mounted on retractable spring castors to enable the steps to be easily moved into position. When under the operator weight steps lower to grip the floor.

Spiggot OD 18.5mm*

Spiggot Length 85mm

Fixing Hole dia: 5mm

Fixing hole centre from base of tube 10mm

The I/D of the tube on the step itself that we have is 24.1mm* so there is a fair amount of clearance / tolerance!



TRAY TROLLEYS

CLASSIC TRAY TROLLEYS

Choice of elegant and smart removable and reversible white or blue trays in blue frame, or fixed ply shelves. Tough durable epoxy finish throughout.

2 or 3 removable steel trays or fixed ply shelves.	125mm dia.
Removable and reversible steel trays for flush or recessed fitting.	Stem fitting castors.
Welded tube and angle construction.	Grey non marking tyres with thread guards.
Overall height 1065mm.	Max load: 200kg



NO. OF TRAYS	2-TRAYS		3-TRAYS	
TRAY SIZE L X W MM	760 x 457	2.00M	2.00M	2.00M
TRAY HEIGHTS MM	245 : 945	508	508	508
WEIGHT KGS	25	380	380	380
ICTTW SERIES REF	ICTT62	ICTT66	ICTT63	ICTT67
WHITE EPOXY TRAYS				
ICTTB SERIES REF	ICTT72	ICTT76	ICTT73	ICTT77
BLUE EPOXY TRAYS				
TT60 SERIES REF	ICTT60	ICTT64	ICTT61	ICTT65
FIXED PLY TRAYS	20	31	27	41

HEAVY DUTY TRAY TROLLEYS

Special heavyweight tray trolleys custom built to your specification if required. Strong construction from square and round section steel tubes and steel shelves with lip.

3 removable steel trays or fixed ply shelves.	200mm dia.
Solid rubber tyre	Red centred wheels fitted
Welded tube and angle construction.	Roller bearing.
Finish Blue epoxy.	Max load: 350kg



NO. OF TRAYS	3-TRAYS	
HEIGHT MODEL	900MM	1200MM
O/A LENGTH X WIDTH X HEIGHT	1090 x 500 x 900	1090 x 500 x 1200
EXTERNAL TRAY SIZE L X W	900 x 500	900 x 500
BOTTOM SHELF HEIGHT	280	280
MIDDLE SHELF HEIGHT	590	740
TOP SHELF HEIGHT	900	1200
WEIGHT KGS	56	58
REF	ICTT34	ICTT35

TABLE TRUCKS

TABLE TRUCKS

Ideal truck series for tough work in Stores, Warehouses, Factories and Workshops.

Welded steel construction throughout.	Wheels: 2 fixed 2 swivel castors
Overall length = Deck length + 135mm	200mm dia. Rubber tyred wheels.
Overall width = Deck width + 20mm	Max load: 500kg
Finish: Blue epoxy.	

RECESSED DECK OPTION

Recessed top and bottom decks optional at no extra cost.
Add suffix RD to chosen Ref.



DECK SIZE	1000 X 600MM		1000 X 700MM		1200 X 800MM	
TYPE	TOP DECK ONLY	TOP AND BOTTOM DECK	TOP DECK ONLY	TOP AND BOTTOM DECK	TOP DECK ONLY	TOP AND BOTTOM DECK
TIMBER DECK REF WEIGHT KGS	ICTT205T 42	ICTT200T 52	ICTT230T 46	ICTT210T 56	ICTT240T 53	ICTT220T 66
STEEL DECK REF WEIGHT KGS	ICTT205S 40	ICTT200S 48	ICTT230S 44	ICTT210S 52	ICTT240S 50	ICTT220S 64

NARROW AISLE SHELF TRUCKS

SHELF TRUCKS

Ideal for Warehouses, Stores, Supermarkets, Factories, Offices. 1,2,3 and 4 deck models.

Overall Length x Width: 1070 x 600mm	High quality red epoxy coated finish tubular chassis frame.
Overall Height: 1,2 & 3 deck models: 1160mm	2 fixed 2 swivel castors with 160mm dia. Rubber tyred wheels with bright steel centres. Brakes optional.
Overall Height 4 deck model: 1500mm	Bright zinc plated mesh infill panels as required.
Deck Length x Width 1000 x 600mm	Fixed timber shelves with bright steel protector strips on both long sides.
Smart and attractive, narrow overall width - only 600mm	



ICTT100 2 DECKS	DECKS AT: 290 : 880MM		
	COMBINATIONS	WEIGHTS KGS	REF
MODEL A	2 fixed open ends	38	ICTT100



ICTT100 3 DECKS	DECKS AT: 290 : 650 : 1010MM		
	COMBINATIONS	WEIGHTS KGS	REF
MODEL B	2 fixed open ends	46	ICTT113



ICTT100 4 DECKS	DECKS AT: 290 : 650 : 1010 : 1370MM		
	COMBINATIONS	WEIGHTS KGS	REF
MODEL C	2 fixed open ends	57	ICTT116

BOOKLET TROLLEYS

Popular design for libraries, offices, classrooms, laboratories etc.

Popular design for libraries, offices, classrooms, laboratories etc.	Fitted with 4 swivel castors 100mm, grey non-marking tyres and thread guards.
Single with flat shelves and double sided with angled shelves.	Available in Different colours.
Strong all steel construction finished in cream epoxy.	Max Load: 150kg
Overall L x W: 840 x 470mm.	



2 TIER	SINGLE SIDED	DOUBLE SIDED	3 TIER	SINGLE SIDED	DOUBLE SIDED
O/A HEIGHT	940	955	O/A HEIGHT	1265	1325
SHELF HEIGHTS	185 / 580	185 / 655	SHELF HEIGHTS	185 / 540 / 895	185 / 600 / 1020
O/A L X W	840 x 390	840 x 470	O/A L X W	840 x 390	840 x 470
WEIGHT KGS	27	35	WEIGHT KGS	38	46
RED REF	ICTT24/R	ICTT21/R	RED REF	ICTT25/R	ICTT22/R
GREEN REF	ICTT24/G	ICTT21/G	GREEN REF	ICTT25/G	ICTT22/G
YELLOW REF	ICTT24/Y	ICTT21/Y	YELLOW REF	ICTT25/Y	ICTT22/Y
BLUE REF	ICTT24/B	ICTT21/B	BLUE REF	ICTT25/B	ICTT22/B

Double sided with angled shelves.	Fitted with 4 swivel castors 125mm grey non-marking tyres and thread guards.
Tubular steel frame with sheet steel shelves.	Weight: 37kg
Overall L x W x H: 880 x 550 x 1115mm	Max load: 250kg
Available in different colours.	

